





Tire sensor container

Mounting the container and installing the tire sensor

  Installation Manual
Tire sensor container with Cyberbond

1	Introduction.....	3
1.1	Use.....	3
1.2	Safety precautions.....	3
1.3	Information on this installation manual.....	4
1.4	Warranty terms.....	5
1.5	Liability disclaimer.....	5
2	Design and Function.....	6
2.1	Description of functions.....	6
2.2	Overview.....	6
3	Setup.....	7
3.1	General instructions.....	7
3.2	Installing the tire sensor container with tire sensor.....	7
3.3	Removing venting ribs in the installation area.....	15
3.4	Final inspection of the adhesive bonding of the tire sensor container.....	19
3.5	Instructions for tire fitting.....	20
3.6	Retreading.....	20
3.7	Continued use of the tire sensor after changing a tire.....	20
4	Technical data.....	21
4.1	Ambient conditions.....	21
4.2	Tire sensor container.....	21
4.3	Tire sensor.....	21
4.4	Approved tires.....	22
5	Disposal.....	23

NOTE	
-------------	--

<p>Use these installation instructions only in conjunction with the "General Safety Notes" (document no.: General_Safety_V01_122020).</p>

Introduction

1 Introduction

1.1 Use

1.1.1 The intended use

The tire sensor container is intended to be installed exclusively in a commercial vehicle tire according to the specifications (see chapter “**4.4 Approved tires**”) and to accommodate a corresponding tire sensor and hold it safely in the tire for operation.

1.1.2 Foreseeable misuse

Any use of the tire sensor container and the system other than the intended use and/or other use is not permitted.

No claims of any kind will be accepted for damage resulting from use of the appliance for other than its intended purpose.

1.2 Safety precautions

In addition to the safety instructions specified in these installation instructions, the “General Safety Notes” (document no.: General_Safety_V01_122020) belonging to the product must be observed.

Hazards that could occur during a particular action are described before the instructions for each step.

Failure to observe the “General Safety Notes” and procedural instructions specified in these installation instructions can lead to considerable hazards and severe injuries to persons.

1.3 Information on this installation manual

These installation instructions are intended for qualified staff in workshops for tire fitting, tire repair and tire service.

Qualified staff is defined as staff that:

- has expertise in tire fitting and repair,
- was trained by a qualified trainer

The certification of the trainer and the training certificate of the installation staff must be documented.

The contents of these installation instructions help to install the tire sensor container into the tires of commercial vehicles.

The information and procedural instructions contained herein refer only to the tire sensor container inclusive sensor.

Introduction

1.4 Warranty terms

The respective relevant "Continental AG terms and conditions" apply with the exception of possible different contractual agreements.

1.5 Liability disclaimer

Continental Reifen Deutschland GmbH assumes no liability for damage and operational faults resulting from:

- Failure to observe this installation manual,
- use for other than the intended purpose,
- employment of unqualified or insufficiently qualified and correspondingly instructed staff,
- faulty installation,
- not using original replacement and accessory parts,
- technical modifications and alterations, conversions and changes to the system are expressly prohibited.
- Failure to perform the prescribed visual inspections (see chapter "**3.4 Final inspection of the adhesive bonding of the tire sensor container**") after installation of the tire sensor.

NOTE	
<ul style="list-style-type: none">▶ The fitter assumes all risks associated with improper installation.▶ The functionality of the sensor in conjunction with the use of balancing substances or any other liquids may be impaired and warranty claims may expire.	

2 Design and Function

2.1 Description of functions

The tire sensors are mounted in tire sensor containers on the inside of the tires. The tire sensor containers and their cushion gum are attached to a prepared surface on the inner layer of the tire by a special adhesive.

The tire sensors are inserted into a tire sensor container and consist of a pressure sensor, temperature sensor, acceleration sensor, evaluation circuit, radio transmitter and lithium battery. The unit is cast in a plastic housing.

2.2 Overview

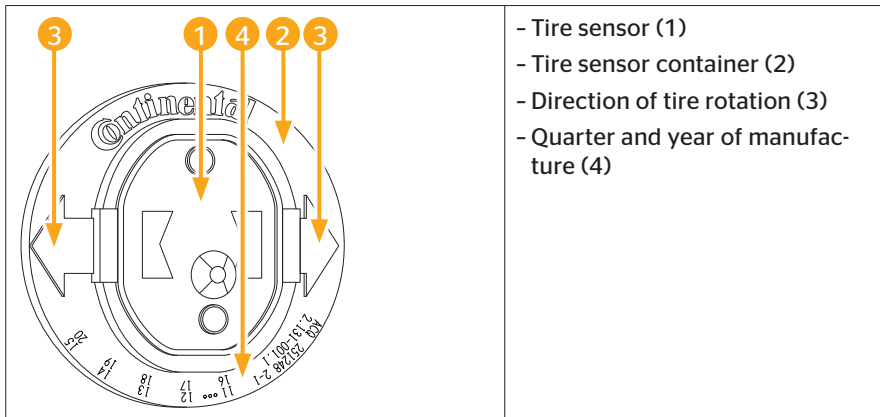

3 Setup



3.1 General instructions

- To install correctly, it is essential to follow the sequence of steps described below.
- The tire sensor and tire sensor container must be installed no later than 2 years after packaging due to ageing of the plastics (especially the tire sensor container) and due to the battery storage time of the tire sensor before use (service life in operation).
- The period of use may be shorter for the chemical and auxiliary materials (note the information on storage time and type on the packaging).

3.2 Installing the tire sensor container with tire sensor

3.2.1 Tools required

All tools and materials listed below are not included in the scope of delivery.

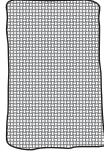
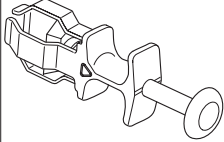

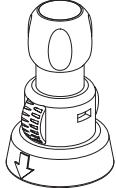
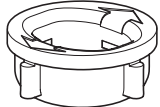
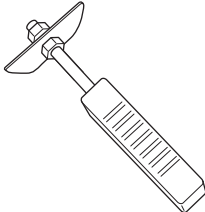
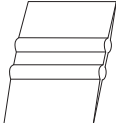
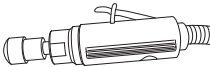
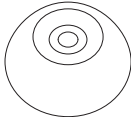
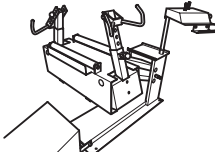
Protective gloves (not included in the delivery)	
1 x brass brush For removing dust particles from the prepared surfaces. (not included in the delivery)	
1 x lint-free paper disposable cleaning wipes Cleaning wipes for cleaning the bonding surfaces. (not included in the delivery)	
1 x HAZET tool article no.: 17341410000 Tool for inserting the tire sensor into the tire sensor container.	

<p>1 x pressing tool 2 article no.: 17341750000 Tool for pressing the tire sensor with tire sensor container when applying to the bonding surface.</p>	
<p>1 x Inlax (inlay) for pressure tool 2 Inlay for holding the tire sensor container in the pressure tool.</p>	
<p>1 x cleaning scraper article no.: 17341080000 Scraper for pre-treating inner layer of the tire.</p>	
<p>1 x Spatula Tool for spreading the adhesive on the tire sensor.</p>	
<p>Pneumatic grinder, slow-running (max. 4000 rpm) (not included in the delivery)</p>	
<p>Contour disc, for low speeds (65 mm, K 36) Only to remove venting ribs if required. (not included in the delivery)</p>	
<p>1 x tire spreader For fixing and spreading the tire during processing.</p>	

Setup

3.2.2 Materials required

ATTENTION	Damage to equipment!
<p>If agents other than the prescribed adhesive and the prescribed cleaning agent are used or the installation instructions are not observed, the tire sensor or the tire sensor container may come loose. This could lead to damage to both the tire and the tire sensor.</p> <ul style="list-style-type: none"> ▶ "Liquid Buffer" or "Pre-Buff Cleaner" from REMA TipTop is prescribed for cleaning the installation area. When using other products, it cannot be guaranteed that the adhesive bond is sufficient. ▶ When fitting the tire sensor, the use of Cyberbond CB 2250 is mandatory. ▶ Observe the adhesive Cyberbond CB 2250 safety instructions. ▶ The tire and the tire sensors container must correspond to the recommended ambient temperature. ▶ After the recommended pressing time, the adhesive exhibits enough basic stability to allow tire fitting. 	

<p>Cleaner</p> <p>1 x cleaning agent containing naphtha ("Liquid Buffer" from REMA Tip Top) Cleaner for pre-treatment of the tire inner layer and the bonding surface of the tire sensor.</p>	
<p>Adhesive Cyberbond CB 2250</p> <p>1 x Cyberbond CB 2250</p> <p>Size S (1.6 g) article no.: 17341130000</p> <p>Size M (4.8 g) article no.: 17341120000</p> <p>Size L (9.6 g) article no.: 17340200000</p> <p>Adhesive for fixing the tire sensor container.</p>	

3.2.3 Fixing position in the tire

The correct position of the installation area is:

- in the middle, on a smooth surface on the inner layer of the tire outside the venting ribs and other bumps.

The aim is for the tire sensor container to cover the entire surface.

It is particularly important to ensure that the edge area of the tire sensor container is flush.

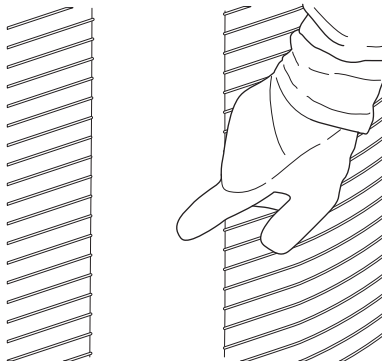

Dimensions of the installation area:	approx. 6.6 x 6.6 cm (approx. 2.6 x 2.6 inches)
Dimensions of the area to be cleaned:	approx. 7 x 7 cm (approx. 2.76 x 2.76 inches)

3.2.4 Inserting the tire sensor into the tire sensor container (Option)

As option if the tire sensor is not assembled into the tire sensor container.

Inserting without tool

- Turn the sealing lip of the tire sensor container inside out.
Tip: Turning the sealing lip inside out on the short side of the tire sensor container is the easiest way (see black arrow in the adjacent illustration).
- Moisten the remaining surface in the tire sensor container slightly with fitting paste.
- Insert the tire sensor into the tire sensor container. The direction of rotation arrows on the tire sensor container continue onto the sensor (see illustration). Make sure that the pressure channel of the tire sensor is not installed upside down when fitting.
- Push the sealing lip of the tire sensor container back up. The sealing lip of the tire sensor container must lie uniformly around the circumference on the top of the sensor.
- In order for the tire sensor to sit better inside the container, it is recommended to position the tire sensor in the container by turning it correspondingly to the right/left.

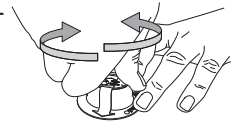
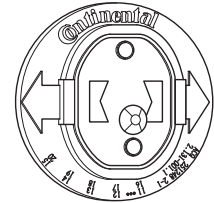
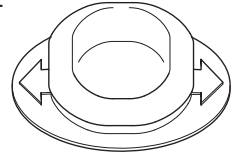
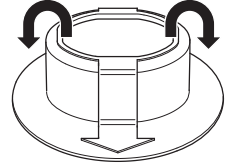

Alternative:

Inserting with tool (HAZET tool)

- HAZET- Press and hold the tool so that the holder for the tire sensor opens.
- Insert the tire sensor into the HAZET tool with the upper side first and stop operating the HAZET tool. The tire end sensor is held by the HAZET tool.
- Insert the tire sensor into the tire sensor container with the HAZET tool. The direction of rotation arrows on the tire sensor container continue onto the sensor (see illustration). Make sure that the pressure channel of the tire sensor is not installed upside down when fitting.
- Hold the HAZET tool and pull it out of the tire sensor container. The sensor remains in the tire sensor container and is held by the sealing lip.

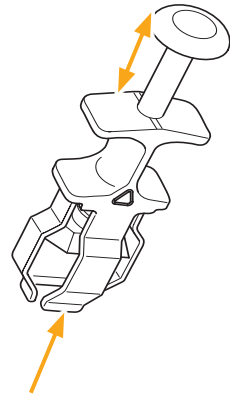

The tire sensor is correctly installed in the tire sensor container when:

1. the direction of rotation arrows continue exactly flush to the tire sensor.
2. a slight elevation on the surface of the tire sensor is visible and can be felt.

Faulty installation causes damage to the tire sensor during operation. The system indicates "**CHECK SENSOR / DISMANTLE TIRE**" in this case.

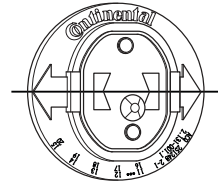

Setup

3.2.5 Pre-treatment of the installation area

Cleaning:

- To clean the installation area, align the tire so that excess cleaning agent can flow out of the area.
- Shake the spray can (Liquid Buffer).
- Spray the installation area to be cleaned completely with the cleaner at a distance of approx. 20 cm (8 inches).
- Immediately afterwards, use considerable pressure to scrape the installation area to be cleaned several times until the surface is dry. Take care not to damage the tire inner layer.
- Repeat the cleaning process at least 2 times.
- Afterwards, moisten the entire installation area to be cleaned with the cleaning agent and clean thoroughly with the cleaning paper.
- Wipe in one direction only and always use clean areas of the cleaning paper.
- Do not rub any dirt into the installation area.
- Repeat this process until the area to be cleaned clearly differs from the uncleaned area.
- Remove any residue from the tire caused by scraping and cleaning.
- Allow the cleaned surface to breathe for approx. 3 minutes after the cleaning steps.

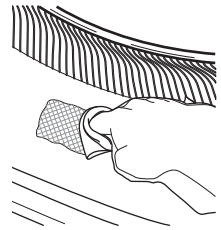
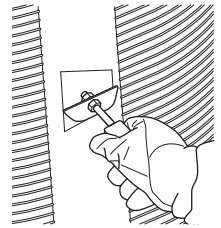

Explanation of the inner liner surface with color reference

	
Red zone:	venting ribs
Yellow zone:	honeycom structure still okay
Green zone:	smooth area for installation
ONLY if no “yellow” or “green” area:	Venting ribs must be removed before cleaning of innerliner as described in chapter <i>“3.3 Removing venting ribs in the installation area”</i>

3.3 Removing venting ribs in the installation area

ATTENTION	Tire damage due to damage to the tire inner liner!
Damage to the tire inner liner can cause impairment of the service life of the tire.	
▶ Remove only the venting ribs.	
▶ Have the work carried out only by staff trained in tire repairs.	

Tool required:

- Marking pen or chalk
- Goggles, protective gloves
- Slow-running pneumatic grinder
- Brass brush
- 65 mm/K36 (2-1/2", SSG230) contour disc
- Wet/dry vacuum cleaner

Proceed as follows:

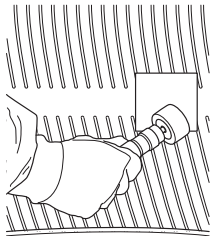

- Mark the area of approx. 7 x 7 cm (2.76 x 2.76 inches) to be roughened with a marking pen or chalk.
- Roughen the tire inner-liner with a contour disc. At the same time, remove all venting ribs in bonding area until the surface is smooth. Only press the contour disc lightly and move continuously to prevent holding down at one place.

NOTE	
▶ Create a rough patch of Type TRMG Buff Texture 1-2 using the contour disc.	

- Clean the roughened area with a brass brush.
- Completely remove all roughening dust with a wet/dry vacuum cleaner.
- Subsequently continue the bonding process as described from chapter **“3.2.5 Pre-treatment of the installation area”**.

3.3.1 Apply the tire sensor with container to the prepared installation surface

- Check the inlay for dirt.
Replace a dirty inlay.
- Place the inlay part in pressing tool 2 so that both arrows on the inlay part correspond with those on pressing tool. Do not use the pressing tool without the inlay part.

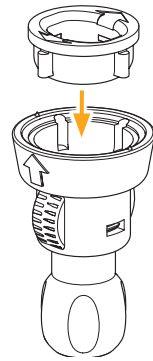

- Insert the tire sensor container with integrated tire sensor into the inlay so that the two rotation direction arrows of the tire sensor match those of the inlay.

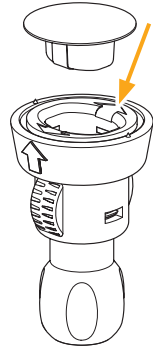

- Shake the spray can (Liquid Buffer or Pre-Buff Cleaner).
- Spray the cleaning agent onto a cleaning cloth.
- Clean the bonding surface of the tire sensor container with the moistened cleaning cloth.
- Perform this cleaning process at least 2x, but continue until the area to be cleaned clearly differs to the uncleaned area.
- Allow the cleaned surface to breathe for approx. 3 minutes after the cleaning steps.



Setup

Apply the adhesive:

- Apply approx. 1 thin line (recommended amount of 0.7 grams) of the special adhesive over the complete diameter of the bonding surface of the tire sensor container and spread uniformly using the spatula. A fluorescent agent was added to the CB 2250 adhesive. This makes it possible to check for proper selection and distribution of the adhesive after bonding.
- After applying the adhesive-CB 2250, ensure that the adhesive and the contact surface are not touched.



ATTENTION

The tire sensor container with integrated tire sensor must be positioned optimally to function properly.

- ▶ Positioning of the tire sensor is correct when the arrow on the tire sensor container points in the direction of the in direction of motion of the tires.

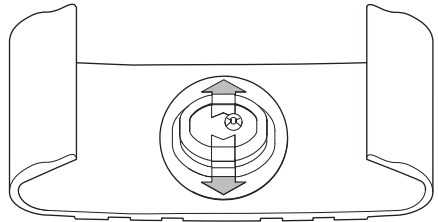

Positioned properly

- Immediately after applying the adhesive, press the tire sensor container with integrated tire sensor perpendicularly onto the cleaned bonding surface using the pressing tool.

NOTE

The expected drying time of the adhesive Cyberbond CB 2250 depending on the ambient temperature:

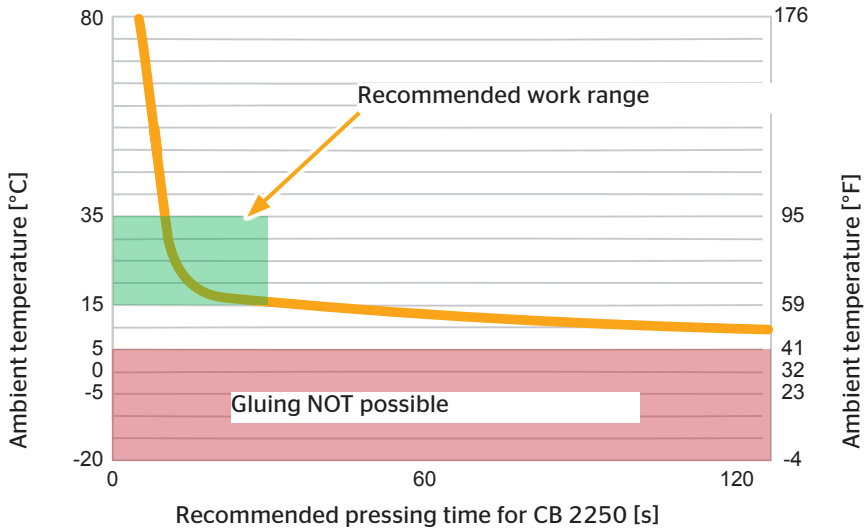

- After the recommended pressing time, the adhesive exhibits enough basic stability to allow tire fitting.

If necessary, perform a tensile stress test after the drying time to determine whether the adhesive has dried.

- Align the arrows on the pressing tool with the direction of travel of the tire and press the bonding surface of the tire sensor container onto the prepared installation surface in the tire.
- The contact pressure required is indicated by the spring stop.
- Ensure contact pressure for at least 45 s.
Do not move the pressing tool during the pressing time!
- Then remove the pressing tool carefully.

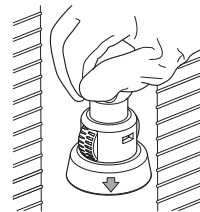

3.4 Final inspection of the adhesive bonding of the tire sensor container

Pay attention to the The following points after installation:

- The bonding time depends on the ambient conditions (temperature and humidity). The ambient temperature must be at least 15°C (59°F). Never try to shorten the drying time by using other means (e.g., compressed air, hair dryer, hot air dryer, ...).
- Do not pull on the tire sensor or the tire sensor container during (at least) the first 15 minutes.
- Inspect the bond visually.
When bonded properly, the tire sensor container with integrated tire sensor is lying completely on the inner layer of the tire.

NOTE	
<ul style="list-style-type: none">▶ If other agents (e.g., Tech720 tire mounting fluid) are used when fitting the tires on the rim, the full curing time of 24 hours must be observed so that the fluid does not damage the bonding system.▶ If mounting pastes are used (only the bead area is coated with mounting paste), the tire can be fitted on the rim after waiting for min. 15 minutes.	

3.5 Instructions for tire fitting

ATTENTION	Damage to equipment!
<p>Improper tire fitting on the vehicle can cause damage to the tire sensor.</p> <ul style="list-style-type: none"> ▶ Do not fit the tires until the full curing time of 24 hours has elapsed. ▶ Make sure that the tire sensor is not damaged when fitting tires using tools such as tire irons. 	

- For tire pairs:
To simplify the teach-in process of the tire sensors, fit the tire pairs so that the valves and therefore the position of the tire sensors are offset at 180° to one another.
- After fitting the tires, it is recommended to mark the tires that contain a tire sensor.
Coloured valve caps and corresponding stickers for the wheel housing/mudguard can be used for this purpose.

NOTE	
<p>Suitable valve caps and stickers can be ordered. Contact the authorised seller or an authorised partner workshop.</p>	

3.6 Retreading

- Before retreading the tire, remove the tire sensor. The tire sensor container can remain in the tire, but must no longer be used to hold a tire sensor.

NOTE	
<p>After retreading, the tire sensor must be placed in a new tire sensor container and fitted according to chapters “3.2.4 Inserting the tire sensor into the tire sensor container (Option)” to “3.3.1 Apply the tire sensor with container to the prepared installation surface”.</p>	

3.7 Continued use of the tire sensor after changing a tire

When the tire sensor is to be used again or replaced/or refitted, pay attention to the specified battery service life or operating time of the sensors according to chapter “**4.3 Tire sensor**” into consideration.

Technical data

4 Technical data

4.1 Ambient conditions

Storage temperature (according to applicable standard)	15 to 25 59 to 77	°C °F
Processing temperature	18 to 45 65 to 113	°C °F
Relative humidity	30 - 80	%

4.2 Tire sensor container

Diameter	60 2.36	mm inch
Height	22.2 0.874	mm inch
Weight	20 0.71	g oz

4.3 Tire sensor

Dimensions (L x W x H)	38 x 28 x 22 1.5 x 1.1 x 0.87	mm inch
Weight	26 0.92	g oz
Transmission frequency	433.92	MHz
Reception frequency	125	kHz
Typical service life* of the permanently installed battery approx.	6 or 600 000 372 820	years km miles
Temperature measuring range	-40 to 120 -40 to 248	°C °F
Pressure measuring range (rel.)	0 to 12 0 to 173	bar psi

* Constantly high tire inside temperatures (caused for example by high ambient temperature, low tire pressure, etc.) can lead to a decrease of the battery service life.

4.4 Approved tires

With proper installation, all standard commercial tubeless tires are fundamentally suitable for the installation of a tire sensor as long as the surface of the tire inner layer corresponds to the normal market conditions.

The tire sensor must not be used in tires with inner tube.

NOTE	Approved tires
<p>The current table of approved tires can be found at https://www.continental-tires.com/transport/products/overview-product-lines/contipressurecheck/about.</p> <p>Contact local customer service for information on approved Continental Commercial Specialty Tires (CST).</p>	

5 Disposal



Consumables and packaging material

Dispose of materials no longer needed, including packaging materials according to local regulations.



Tire container and tire sensor

The tire sensor container remains in the tire and is disposed of with the tire.

NOTE	
Before disposing of a tire, the tire sensor must be taken out. If the tire sensor is to be used further, take the specified battery life or mileage of the sensor into account according to the chapter “4.3 Tire sensor” .	

The tire sensor contains a lithium battery that is cast into the housing and cannot be replaced.

After reaching the end of its service life, the tire sensor must be disposed of in accordance with all current local, regional and national laws and regulations. For this purpose, it is necessary to return it to an authorised Continental sales partner or the central collection point.

Address of the central collection point:

Continental Trading GmbH

„Abteilung Entsorgung“

VDO-Straße 1

Gebäude B14

64832 Babenhausen

Germany

Continental Reifen Deutschland GmbH

Vahrenwalder Straße 9

30165 Hannover

Germany

www.contipressurecheck.com

www.continental-truck-tires.com

www.continental-corporation.com

Continental 
The Future in Motion

IM_Tire sensor container_CB 2250_EN_V01_122020